

HAKI Komponentliste

Innhold

HAKI UNIVERSAL	3
HAKI UNIVERSAL S4 ALUMINIUM	21
HAKI UNIVERSAL S6 ALUMINIUM	24
HAKI UNIVERSAL APPLIKASJONER	26
HAKI RAMME	38
RØR OG KOPLING	43
HAKITEC 750 VÆRBESKYTTELSE	44
HAKITEC INNDEKKNING	51



HAKI forbeholder seg retten til løpende tekniske forandringer.

© Copyright HAKI AS, 2021

HAKI AS • Postboks 444, 3002 Drammen, Norway • +47 32 22 76 00 • info@haki.no • www.HAKI.no

Bunnkomponenter

	Kode	Utfør.	Art. nr	Vekt
Bunnskrue	BS	G	2071000	5,0
	BSL	G	2073003	9,2
Justerbar				
BS=55-570 mm				
BSL=40-650 mm				

Spirer

		Utfør.	Art. nr	Vekt
Spire S	S 500	G	7016050	2,9
	S 1000	G	7016100	5,3
	Spireskjøt med tapp Ø 38 mm	G	7016150	7,7
	Rørdiameter 48 mm	G	7016200	10,1
	S 3000	G	7016300	15,2

Splint til spireskjøt

Diameter 16 mm
 For forsterkning av spireskjøt
 ved trekklast f eks ved hengende
 stillas, løft eller stillas for værbeskyttelsestak



Låsesplint m/fjær 16	G	2116000	0,17
Låsesplint for offshore	G	5141257	0,3

Horisontaler



		Utfør.	Art. nr	Vekt
Lengdebjelke	1050	G	7021102	4,8
	1250	G	7021122	6,5
	Med fjærlås	G	7021162	6,7
	Rørdiameter 34 mm	G	7021192	8,0
	Lengder fra 1050-4050	G	7021252	10,9
	2500	G	7021302	12,3
	3050	G	7021361	22,6
	3650	G	7021401	24,8
4050	G	7021401	24,8	
Enrørsbjelke	564	G	7022050	3,1
	700	G	7022066	3,3
	Med fjærlås	G	7022073	3,6
	Rørdiameter 48 mm	G	7022101	4,4
	Lengder fra 564-3050	G	7022121	5,1
	1250	G	7022161	6,3
	1655	G	7022161	6,3
	1964	G	7022191	7,3
2500	G	7022246	8,9	
3050	G	7022301	11,3	

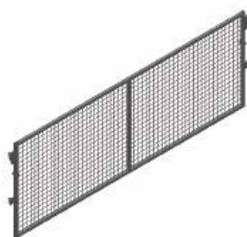
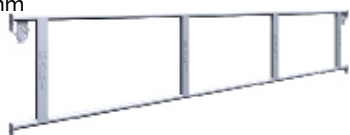

Rekkverk

		Utfør.	Art. nr	Vekt
Rekkverksramme GFL Med fjærlås Rør octagon 28 mm	564	G	7052056	3,8
	700	G	7052070	3,8
	770	G	7052077	4,0
	1050	G	7052106	4,9
	1250	G	7052124	5,7
	1655	G	7052164	7,4
	1964	G	7052194	8,1
	2357	G	7052232	8,9
	2500	G	7052254	9,2
	3050	G	7052304	10,5
Rekkverksgrind med nett SGF Trinnløst justerbart 118 mm i høyden for å kunne tilpasses ulike innplankinger Nøkkelvidde 22 mm	1050	G	7055101	13,3
	1250	G	7055121	14,6
	1655	G	7055161	17,0
	1964	G	7055191	19,4
	2500	G	7055250	23,2
	3050	G	7055300	26,8

Stag

		Utfør.	Art. nr	Vekt	
Diagonalstag DS Med kilekoplinger. Rørdiameter 48 mm	DS 1250 L=2004	G	7122124	9,0	
	DS 1655 L=2285	G	7122164	10,1	
	DS 1964 L=2523	G	7122194	10,9	
	DS 2500 L=2967	G	7121254	12,6	
	DS 3050 L=3450	G	7121304	14,3	
	DS 3650 L=3988	G	7121364	16,2	
	DS 4050 L=4357	G	7121404	17,5	
					
	Diagonalstag for trall/labanklemmer Med kilekoplinger Rørdiameter 48 mm	DS-UB 3050 L=3448	G	7121301	15,5
					

		Utfør.	Art. nr	Vekt
Horisontaldiagonal HDS	3050x1655	G	7141000	13,3
	3050x1250	G	7141001	13,2
Med kilekoplinger				
Rørdiameter 48 mm				
HDS 3050x1655 L=3472				
HDS 3050x1250 L=3298				







Forankring

		Utfør.	Art. nr	Vekt
Veggfestestag rør SVF	450x48	G	8832046	2,2
	600x48	G	8832061	2,6
	Rørdiameter 48 mm	G	8832091	3,7
	Krok diameter 16 mm	G	8832121	4,8
	Tillatt belastning 9 kN			
Monteres med kopling fast 48x48				
Veggfeste justerbart		G	8832110	4,9
	Justering 650 - 1100mm			
Krok 16mm				
Tillatt belastning 5,2 kN				
Monteres med kopling fast 48x48				
Kompositteveggfeste	700x48		2021405	1,0
	1000x48		2021403	1,2
	Krok 12mm		2021407	0,1
	Tillatt belastning 3,0 kN			
Monteres med kopling fast 48x48				
Kan leveres i forskjellige farger				
og med logo iht kundens ønsker.				
Angitt pris er for kjøp av min. 500 stk. Ekstrakostnad for logo er NOK 11,- pr stk.				
Veggstag VST	1000	G	7111100	5,3
	2000	G	7111200	9,1
	Med leddet plate	G	7111300	13,7
	Rørdiameter 48 mm	G	7111400	16,7
	Monteres med kopling fast 48x48	G	7111500	21,9
	For tillatt belastning, se produktdatablad	G	7111600	24,5



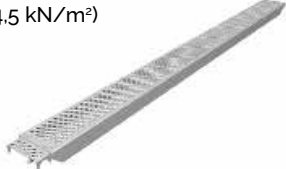
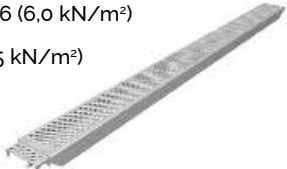





Innplanking

		Utfør.	Art. nr	Vekt
Stillaslem Alu 	1250x498x55	AL	2021145	7,8
	1250x398x55	AL	2021146	6,6
	1250x595x55	AL	2021164	8,4
Komposittlem Kan også leveres med kundens egen firmalogo 	1250x490		2021406	8,0
Stige ST Til Krokplan med luke 	2100	AL	2091210	3,4
AL plank B=170 mm L=564-2500 - Lastklasse 6 (6,0 kN/m ²) L=3050 - Lastklasse 5 (4,5 kN/m ²) 	564x170x90	AL	2153056	2,9
	770x170x90	AL	2153081	3,1
	1050x170x90	AL	2153106	4,3
	1250x170x90	AL	2153126	4,8
	1655x170x90	AL	2153166	6,0
	1964x170x90	AL	2153196	6,8
	2500x170x90	AL	2153247	8,3
	3050x170x90	AL	2153306	9,8
AL plank B=230 mm L=564-2500 - Lastklasse 6 (6,0 kN/m ²) L=3050 - Lastklasse 5 (4,5 kN/m ²) 	564x230x90	AL	2153055	3,4
	770x230x90	AL	2153080	4,1
	1050x230x90	AL	2153100	4,9
	1250x230x90	AL	2153120	5,6
	1655x230x90	AL	2153160	6,9
	1964x230x90	AL	2153190	7,8
	2500x230x90	AL	2153245	9,5
	3050x230x90	AL	2153300	11,2
Lukeplan AL B=690 mm L=1250-2500 - Lastklasse 6 (6,0 kN/m ²) L=3050 - Lastklasse 5 (4,5 kN/m ²) 	1250x690	AL	4098123	19,9
	1655x690	AL	4098163	23,7
	1964x690	AL	4098193	26,6
	2500x690	AL	4098253	31,6
	3050x690	AL	4098303	36,7

Innplanking

		Utfør.	Art. nr	Vekt
Alu rampe	1400x500	AL	2157004	7,8
	1400x600	AL	2157005	10,3
Hjørne dekkplater	564x564		4011020	4,5
	770x770		4011021	7,3
	1250x1250		4011022	14,5
Dekkplate B=230 mm Lengder fra 564-3050	564	G	2170564	3,1
	770	G	2170770	3,6
	1050	G	2171050	5,0
	1250	G	2171250	5,9
	1655	G	2171655	7,7
	1964	G	2171964	11,5
	2500	G	2172500	14,5
	3050	G	2173050	15,0
Krokplan B=600 mm	564x170x90	AL	2153056	2,9
	770x170x90	AL	2153081	3,1
	1050x170x90	AL	2153106	4,3
	1250x170x90	AL	2153126	4,8
	1655x170x90	AL	2153166	6,0
	1964x170x90	AL	2153196	6,8

Fotlister

		Utfør.	Art. nr	Vekt
Fotlist	3300x150x34		2025305	5,0
Ubehandlet tre				
Fotlist	FL 3300x150x32		2025331	6,7
Tre, gul transparent				
Fotlist	FL 1300x150x32		2025133	2,7
	FL 3300x150x32		2025333	6,7
Fotlister med farge og logo iht kundespesifikasjon.				
Fotlist Aluminium	700	AL	4161071	1,3
	770	AL	4161077	1,4
	1050	AL	4161105	1,9
	1250	AL	4161121	2,2
	1655	AL	4161161	2,9
	1964	AL	4161191	3,5
	2500	AL	4161251	4,6
	3050	AL	4161301	5,5
				
Fotlist teleskopisk	1200-1964	AL	2026020	5,0
	1900-3050	AL	2026021	7,3
				
Fotlistbeslag			2131003	0,1
Fjærstål				
Låsejern for fotlist			1162001	0,6
				

Konsoller

			Utfør.	Art. nr	Vekt
Konsoll uten spireskjøt		SK 230	G	7211025	1,6
		SK 300	G	7211033	2,0
Rørdiameter 48 mm		SK 334	G	7211035	2,0
Med fjærlås		SK 400	G	7211041	2,1
		SK 460	G	7211045	2,3
		SK 600	G	7211061	2,7
Konsoll med spireskjøt		SK 564	G	7211051	5,8
		SK 700	G	7211067	5,9
Rørdiameter 48 mm		SK 770	G	7211071	6,5
Med fjærlås					
Konsoll justerbar		SK 460-690	G	7211069	4,1
Justerbar 460 - 690 mm					
Lastklasse 3 (2,0 kN/m ²) OBS! Kan ikke monteres i aluminiumsspir					
Konsolldiagonal		SKD 1250	G	7212001	11,1
Kombineres med enrørsbjelke 1250 eller lengdebjelke 1250					
Hjørnekonsoll		SKH 460	G	7211046	6,7
Innvendig hjørnekonsoll - 2 plank Nøkkelvidde 22 mm					

		Utfør.	Art. nr	Vekt
Hjørnekonsoll		G	7211053	18,0

Innvendig hjørnekonsoll - 3 plank
Nøkkelvidde 22 mm



Kombikonsoll KK

700

G

7211065

9,3

For innplanking med RAM-plan







Fagverk

		Utfør.	Art. nr	Vekt
Fagverksdrager	500/6100	G	7031602	59,1



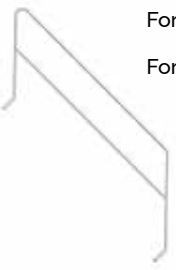



Trapper & Stiger

		Utfør.	Art. nr	Vekt
UTV Trapp AL Med hvilplan og låsing Bredde 600 mm 	UTV Gelender 2500x2000	AL	4058245	9,2
	UTV Gelender 3050x2000	AL	4058300	10,3
	UTV Gelender 3050x1500	AL	4058150	9,3
	UTV Trapp 2500x2000	AL	4102247	22,9
	UTV Trapp 3050x2000	AL	4102302	29,2
	UTV Trapp 3050x1500 med sklisisikre trinn	AL	2153039	26,0
	UTV Trapp 3050x2000 med sklisisikre trinn	AL	2153040	22,0
	Gelenderstolpe LSS 1000	G	7015102	4,2
	Feste LSS-UTV	G	7058300	1,5
UTV Trapp Med hvilplan og låsing oppe LxH 3050x2000 mm Bredde 600 mm 	UTV Trapp 3050x2000	G	2092200	39,7
	Gelender HL 3050x2000	G	2161300	19,3
	Gelenderstolpe LSS 1000	G	7015102	4,2
	Feste LSS-UTV	G	8752001	2,5
UTV Gelender indre Bredde 600 mm For trapp UTV AL og UTV galv. 	For UTV Trapp AL 3050x2000	G	7058253	11,4
	For UTV Trapp galv 3050x2000	G	7058254	11,5
	For UTV Trapp AL 2500x2000	G	7058256	10,4
UTV Trapp AL Med hvilplan og låsing oppe Bredde 600 mm 	UTV 500	AL	4102050	5,5
	UTV 1000	AL	4102100	9,0
	UTV 1500	AL	4102150	11,3
Innstegstrapp 	700/770	G	7103065	7,8

		Utfør.	Art. nr	Vekt
STV Stige med hvilplan	STV 1250	G	7083202	12,5
	STV 1655	G	7083203	17,1
Med hvilplan og låsing oppe				
LxH 1250x2000 mm alt. 1655x2000 mm				
Bredde 475 mm				









SS Opphengsbleslag







		Utfør.	Art. nr	Vekt
SS Opphengsbleslag Gallerdørk		G	7171001	2,4
Tillatt belastning 20,0 kN				
				
SS Opphengsbleslag H-bjelke	80-180	G	7172100	5,7
	150-300	G	7172000	6,8
Tillatt belastning 20,0 kN	300-450	G	7172001	7,6
				
SS Opphengsbleslag L-bjelke	60-120	G	7176000	5,3
Tillatt belastning 20,0 kN				
				
SS Opphengsbleslag Bulb-Kjetting	160x9 - 200x12	G	7177002	2,5
	220x10 - 300x13	G	7177001	2,5
Tillatt belastning 20,0 kN	320x11 - 370x16	G	7177003	3,7
				
SS Opphengsbleslag Bulb-Kjetting		G	7177000	1,6
For bulbplate 160x8 mm				
Tillatt belastning 12,0 kN				
Kan modifieres for andre størrelser på profilen				
				







			Utfør.	Art. nr	Vekt
SS Opphengsbeslag Bulb-Rør			G	7177100	3,0
For bulbplate 160x8 mm Nøkkelvidde 22 mm Tillatt belastning 20,0 kN Kan modifiseres for andre størrelser på profilen					
SS Opphengsbeslag kjetting		1362	G	7175001	4,3
		850	G	7175002	3,0
Tillatt belastning 20,0 kN					
SS Opphengsbeslag KF 48 dobbel			G	7175101	2,1
Hulldiameter 20 mm Nøkkelvidde 22 mm Tillatt belastning 20,0 kN					
SS Klembeslag		500	G	7215032	5,5
Nøkkelvidde 30 mm					
SS Monteringsverktøy til hengende plattform			G	7500032	13,0
					
Stillaskjetting med to sjakler		2 m	G	7175005	4,7
		4 m	G	7175006	8,9
					

Andre komponenter

			Utfør.	Art. nr	Vekt
Bunnskrue leddet 750			G	2071005	5,9
Bunnskrue leddet		BSLL 200	G	7153005	12,0
Bunnspiss		BPS	G	7151002	9,0
Låsefjær til bunnskrue			G	2071100	0,2
Holder bunnskrue på plass ved løft av stillasseksjonen					
Toppspire SC		SC 353	G	7011004	2,0
		SC 853	G	7011104	4,8
		SC 1353	G	7011154	7,3
		SC 1853	G	7011204	9,8
Høydeinnstillingsspire			G	7202001	6,5
Enkelbjelke		300	G	7022030	1,5
		350	G	7022035	1,7







			Utfør.	Art. nr	Vekt
Spireholder	50		G	7208025	2,3
For rørdiameter 50 mm Kan låses med låsesplint 12 mm					
Spireholder	S		G	7208018	3,9
For rørdiameter 34 mm Med låseskrue					
Bjelkeytter	50		G	7208024	1,2
For rørdiameter 50 mm Kan låses med låsesplint 12 mm					
BRS Bjelkeytter		Bøyer på samme nivå	G	7208020	2,0
		Bøyer på høyt nivå	G	7208021	2,4
		Bøyer på lavt nivå	G	7208022	2,5
For rørdiameter 34 mm Med låseskrue					
Bjelkeytter dobbel	21		G	7208033	2,4
	22		G	7208031	2,4
					
Løs Bøylegruppe			G	8792000	0,6
Nøkkelvidde 22 mm For rekkverk ved f. eks. hjørneløsninger					
Låseklammer rekkverk			G	8833000	0,8
Nøkkelvidde 22 mm For rekkverk, rørdiameter 38 mm					



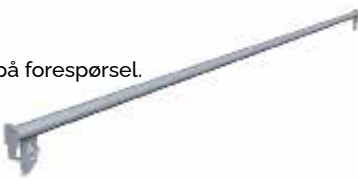



			Utfør.	Art. nr	Vekt
Rekkverksstolpe SRS		1000	G	7015001	7.3
Til montasje på lengdebjelke					
Mellomspire		1000	G	7015004	6.1
Til montasje på lengdebjelke					
Rekkverksstolpe		22	G	7015006	6.1
Nøkkelvidde 22 mm Til montasje på enrørsbjelke					
Sikkerhetsbøyle			G	7053110	5.5
Til montasje på lengdebjelke					
Dekkplate AL		995x495x4	AL	4011000	5.2
		695x495x4	AL	4011001	3.6
AL-dørkplate		495x495x4	AL	4011002	2.5
Med håndtak og hull for surring, til tetting av hull i innplanking					
Dekkplate stål		190 x 1055	G	2153020	3.4
		315 x 1055	G	2153015	5.5
		450 x 1062	G	2153010	7.5
Utfyllingsplater AL		1245 x 227	AL	2750411	2.2
		1645 x 227	AL	2750412	2.9
		1945 x 227	AL	2750414	3.4
		2545 x 227	AL	2750413	4.4
		3045 x 227	AL	2750415	5.3

			Utfør.	Art. nr	Vekt
Beslag skyvbar grind			G	7053001	9.4
Beslaget monteres på rekkverksgrind og kan lage skyvbar port i fakket ved siden av					
Stillastak			G	7214066	9.5
					
Tverrbjelkebeslag		TBJ	G	7201000	1.0
					
Kombinasjonsbeslag		KJS	G	7205010	2.7
					
Plankerytter		460-2 bd	G	7218023	4.0
					
Plankerytter		230-1 bd	G	7218032	3.0
		460-2 bd	G	7218033	3.5
Hjul				2012001	10.6
Hjul diameter 250 mm Justerbar 330-630 mm Tillatt belastning 10.0 kN, rullende 7.5 kN					



			Utfør.	Art. nr	Vekt
Støtteben		STB 1000	AL	4143101	8,6
Justerbar					
Toppgafler		BV 10	G	7155000	3,0
		BVV 175	G	7155131	3,5
BV 10 till omvendt bunnskrue og toppspire, BVV 175 til spire S					
Tripod		500	G	7203340	10,0
		1000	G	7203341	17,3
Med bøyer på ett spir		1500	G	7203344	23,3
Rørdiameter 48 mm		2000	G	7203342	31,8
		3000	G	7203343	45,8
					
Justerbar Bunnskrue 60			G	2071061	15,6
					
Adaptor Tripod		60	G	7203312	11,6
		48	G	7203311	10,0
					
Topplate Tripod		Toppgaffel BVV tripod	G	7155100	3,0
		Topplatta Tripod	G	7203309	6,3
					
Adapter		35		2041001	0,03
Brukes som innlegg i Ø48 kopling for å kunne festes på Ø34 rør					
Låsesplint		12		2113100	0,1
Diameter 12 mm					
Låsesplint for offshore med kjetting		16	G	5141257	0,3
					
Låsesplint m/fjær		16	G	2116000	0,2
					

Øvrige komponenter



		Utfør.	Art. nr	Vekt
Enkeltbjelke	3050	G	8722300	10,5
Andre lengder på forespørsel.				
				
Monteringsverktøy for rekkverk		AL	4052001	1,4
				
Kombinasjonsbeslag		G	7205010	2,2
				
Stillasbukk	SBT	G	7013010	9,2
Med teleskopisk forlengelsesrør				
To stillasbukker kombineres med en bjelke til en bukk				
				
Hakitainer	1100	G	7181110	33,6
	1500	G	7181150	39,4
OBS! Ikke godkjent som løfteredskap.				
Gods skal stropes til Hakitaineren ved løfting med kran				
				
HAKI Galge	Hjul til galge		5211000	3,6
	Kopling m/bøyle	G	7164001	0,9
HAKI Galgen kombineres med linhjul eller HAKI sikkerhetsblokk.	Galge, HAKI	G	7173002	7,9
Kan også brukes til vinsj.				
Kopling med bøyle brukes ved montering på				
for eksempel stillasrør 48 mm.				
Tillat last HAKI Galge 200 kg,				
Linhjul 70 kg				
				

	Utfør.	Art. nr	Vekt
HAKI Offshore galge Ferdig sertifisert, komplett med Sikkerhetsblokk og 30m stillastau med kause og krok. Tillatt last 50 kg.		7173003	25,0
			
HAKI Sikkerhetsblokk Tillatt last 50 kg	Rep Ø 20 mm Sikkerhetsblok Sikkerhetsblokk, HAKI	2600280 26150AF	10,0 4,5
			
Stillastau	30m m/kause og krok 60m m/kause og krok 100m m/kause og krok	2610030 2610060 2610100	12,1 22,1 35,1
Stillasskilt For å henge opp på stillas. Skiltholder og skilt	Skiltholder Skilt	10028 10036	0,1 0,04
			
Øyeskrue Øyebolt med godstykkelse 10mm og øyediameter 20mm. Stålkvalitet 8.8. Elzink. 100 stk pr pakke	Øyeskrue L=100	6130052	0,1
			
Testnøkkel til forankring 350Nm		2051052	2,5
			
Monteringsverktøy låsefjær	Skrallenøkkel 21/22mm Skrallenøkkel 22/23mm	1051001 2051022 2051023	0,5 0,5 0,5
			
Låsefjær		6130000	0,04
			

Spirer

		Utfør.	Art. nr	Vekt	
Spire S4 AL Spireskjøt med tapp Ø 38 mm Rørdiameter 48 mm		S4 500	AL	4017056	1,6
		S4 1000	AL	4017106	2,8
		S4 1500	AL	4017156	4,0
		S4 2000	AL	4017206	5,2
		S4 3000	AL	4017306	7,7
Splint til spireskjøt Diameter 16 mm For forsterkning av spireskjøt ved trekklast f eks ved hengende stillas, løft eller stillase for værbeskyttelsestak		Låsesplint m/fjær 16	Fzb	2116000	0,17
		Låsesplint for offshore	G	5141257	0,3
Toppspire S4 AL		S4 SC 353	AL	4011105	1,0
		S4 SC 853	AL	4011104	2,2
		S4 SC 1353	AL	4011106	3,4
		S4 SC 1853	AL	4011107	4,6
		S4 SC 3000	AL	4011304	7,7

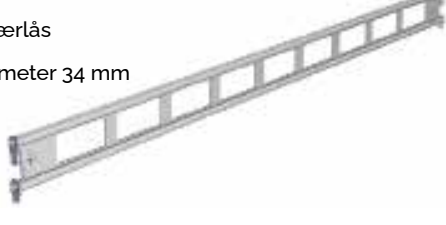

Horisontaler

		Utfør.	Art. nr	Vekt	
Lengdebjelke Med fjærlås Rørdiameter 34 mm		350	AL	4021031	1,9
		770	AL	4021073	2,9
		1050	AL	4021101	3,5
		1250	AL	4021121	4,2
		1655	AL	4021161	4,8
		1964	AL	4021191	5,8
		2500	AL	4021246	7,2
		3050	AL	4021301	8,5
Enrørsbjelke Med fjærlås Rørdiameter 48 mm		564	AL	4022051	2,5
		700	AL	4022066	2,7
		770	AL	4022073	2,9
		1050	AL	4022101	3,2
		1250	AL	4022121	3,6
		1655	AL	4022161	4,1
		1964	AL	4022191	4,5
		2500	AL	4022246	5,4
3050	AL	4022301	6,2		

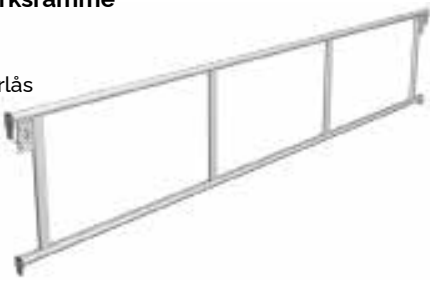
Rekkverk

		Utfør.	Art. nr	Vekt
Rekkverksramme Med fjærlås 	700	AL	4052066	3,3
	770	AL	4052073	3,5
	1050	AL	4052101	4,5
	1250	AL	4052121	4,8
	1655	AL	4052161	5,9
	1964	AL	4052191	6,6
	2500	AL	4052246	7,8
	3050	AL	4052301	8,9

Stag





		Utfør.	Art. nr	Vekt	
Diagonalstag Rørdiameter 48 mm 	1250	AL	4122120	4,5	
	1655	AL	4122160	4,9	
	1964	AL	4122190	5,4	
	2500	AL	4122245	6,1	
	3050	AL	4122300	6,7	
Horisontaldiagonal HDS Rørdiameter 48 mm HDS 3050x1655 AL L=3468 HDS 3050x1250 AL L=3294 HDS 2500x1250 AL L=2792 HDS 2500x1655 AL L=2996 	3050x1655	AL	4141000	7,0	
	3050x1250	AL	4141001	6,5	
	2500x1250	AL	4141005	6,0	
	2500x1655	AL	4141006	6,3	
Horisontaldiagonal teleskopisk HDS Rørdiameter 38-48 mm L=1960-3470 mm For fakkstørrelser fra 1655x1050 mm til 3050x1655 mm med 16 faste posisjoner 		AL	4141010	6,3	

Konsoller

		Utfør.	Art. nr	Vekt
Konsoll Uten spireskjøt Med fjærlås 	SK 230	AL	4211024	1,7
Konsoll Med spirekjøt Med fjærlås 	SK 564	AL	4211052	3,6
	SK 700	AL	4211069	3,8
	SK 770	AL	4211074	3,9

			Utfør.	Art. nr	Vekt
Konsolldiagonal		150-5 Bd	AL	4212002	7,8

Andre komponenter

			Utfør.	Art. nr	Vekt
Spireholder S4 AL			AL	4208002	1,7
Bjelkerytter		BR 34	AL	4208020	1,1
Låselister		700x100	AL	4024070	1,1
		770x100	AL	4024077	1,3
		1050x100	AL	4024105	1,9
		1250x100	AL	4024125	2,3
		1655x100	AL	4024165	3,1
		1964x100	AL	4024190	3,7
		2500x100	AL	4024250	4,8
		3050x100	AL	4024300	6,0
Låseplate			AL	6230800	0,7

Bunnskrue

		Utfør.	Art. nr	Vekt
Bunnskrue for S6 spirer	BS S6-760/515	G	2071032	6,2

Stål
 Ø 34 mm
 Justerbar 55-570 mm

Spirer

		Utfør.	Art. nr	Vekt
--	--	--------	---------	------

Spire S6 AL med splint

Spireskjøt med tapp Ø 34 mm
 Rørdiameter Ø 48 mm
 Med monteret splint



S6 500	AL	4018050	2,2
S6 1000	AL	4018100	3,7
S6 1500	AL	4018150	5,3
S6 2000	AL	4018200	6,8
S6 3000	AL	4018300	9,9

Toppspire S6 AL

S6 SC 353	AL	4018053	1,2
S6 SC 853	AL	4018103	2,8
S6 SC 1353	AL	4018153	4,3
S6 SC 1853	AL	4018253	5,8

Konsoller

		Utfør.	Art. nr	Vekt
--	--	--------	---------	------

Konsoll med spireskjøt S6 AL

SK S6-564

AL

4211053

3,9

SK S6-770

AL

4211075

4,2

Med spireskjøt Ø 34 mm

Rørdiameter 48 mm

Med fjærlås

Konsolldiagonal S6 AL

SKD S6-1250

AL

4212001

7,6

Med spireskjøt Ø 34 mm

Rørdiameter 48 mm

Med fjærlås

Kombineres med enrørsbjelke 1250

eller lengdebjelke 1250

Andre komponenter

		Utfør.	Art. nr	Vekt
--	--	--------	---------	------

Stillashjul S6

LRG S6

AL

2012004

9,6

Ø 34 mm

Hjul diameter 250 mm

Justerbar 330-630 mm

Tillatt belastning 10,0 kN, rullende 7,5 kN

Spireholder S6 AL

S6

AL

4208001

1,8







Med spireskjøt Ø 34 mm



För rørdiameter 34 mm

Kan låses med låsesplint 12 mm





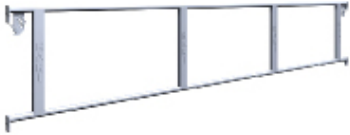

Trappetårn 3050x1655 Symmetrisk

			Utfør.	Art. nr	Vekt
STS Hvilplan			G	7095001	19,2
STS Trappeløp		1000 1500 2000	G G G	7101101 7101151 7101201	38,5 28,6 33,9
STS Gelenderstolpe			G	7015102	4,2
Stolpen låses med låsekrok LK 8793000					
Rekkverksstolpe		22	G	7015006	6,1
Nøkkelvidde 22 mm For montasje på enrørsbjelke					
STS Gelender		1000 1500 2000	G G G	7058103 7058153 7058203	7,0 7,5 8,4
STS Rekkverksgrind		SGTS	G	7053002	10,9
STS Fotlist		873 1655	G G	2025085 2025159	3,1 4,5







			Utfør.	Art. nr	Vekt
STS Rekkverksramme Trappetårn		SGS	G	7053003	7,6
STS Rekkverksramme		GFL 2357	G	7052232	8,9
STS Innstegstrapp		1655	G	7103160	14,7
STS Låsekrok		LK 10x48	G	8793000	0,1

Trappetårn 3050x1655 Tradisjonelt

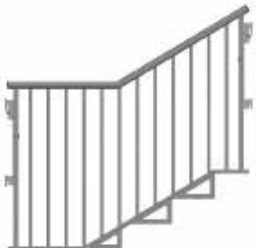



			Utfør.	Art. nr	Vekt
Hvilplan VLP			G	7095000	26,6
Trappeløp TRP		1000	G	7101100	43,6
		1500	G	7101150	28,3
		2000	G	7101200	35,0
SGT Rekkverksramme Trappetårn			G	7053000	7,6
STS Gelenderstolpe			G	7015102	4,2







Offentlig Trappetårn

			Utfør.	Art. nr	Vekt
STC Innstegsbjelke		1250	G	7104120	5.3
STC Innstegstrapp		1250	G	7103120	11.1
STC Fotlist		1250		2025119	3.5
STC Gelender øvre			G	7058252	6.9
STC Gelender komplett			G	7058261	8.6
PAS Trappevange		1655x1000	G	7102100	25.0
		2500x1500	G	7102150	34.5
PAS Gelender		1655x1000	G	7058100	26.5
		2500x1500	G	7058152	36.5

			Utfør.	Art. nr	Vekt
PAS Gelender		1655x500	G	7058050	24,0
PAS Rekkverk		300	G	7053030	7,5
		564	G	7053056	12,1
		770	G	7053077	12,5
		1050	G	7053105	15,7
		1250	G	7053125	19,5
		1655	G	7053165	23,0
		1964	G	7053191	28,2
		2500	G	7053250	34,2
PAS Enrørsbjelke m dekkplate		1250	G	7104125	6,7
		1655	G	7104166	8,5
		1964	G	7104191	10,0
PAS Gelender innsteg		3-trinns	G	7058004	15,0
PAS Trappevange		3-trinns	G	7102006	10,7
PAS Diagonal		1655	G	7125166	8,1
		2500	G	7125251	11,5

HBS Heavy Bridge System

		Utfør.	Art. nr	Vekt
HBS Enrørsbjelke med skrulås SBF 	1250	G	7104124	5,3
	1655	G	7104164	6,6
	1964	G	7104194	7,5
	2500	G	7104254	9,1
HBS Tåreplateplank 	1250x200	G	2140125	13,1
	1250x250	G	2140126	14,9
	2500x200	G	2140255	26,2
	2500x250	G	2140256	29,8
HBS Horisontalstag 	1250x1250	G	7105121	4,4
	2500x1250	G	7105126	8,1
	1250x1655	G	7105161	5,0
	1250x1964	G	7105191	5,7
	2500x1655	G	7105195	7,4
	2500x1964	G	7105197	7,7
	2500x2500	G	7105199	8,7
	1250x2500	G	7105251	6,8
HBS Pilar 	Underdel	G	7104108	23,6
	Overdel	G	7104109	21,5
	Mellomdel	G	7104140	16,0
HBS Sidestag 	4000	G	7104141	16,3
HBS Diagonalstag 	1250	G	7104138	14,8
	2500	G	7104119	17,0



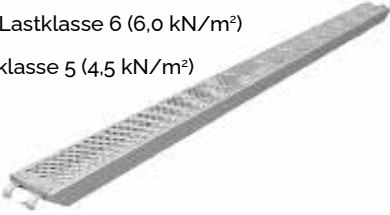
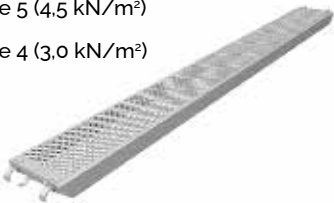
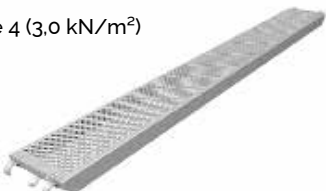

			Utfør.	Art. nr	Vekt
HBS Øvre Bjelke		1250	G	7104135	10,9
		2500	G	7104118	23,2
HBS Nedre Bjelke		1250	G	7104136	12,5
		2500	G	7104130	26,8
HBS Kledningspanel		250x1250		2033120	2,0
		250x2500		2033250	4,0
HBS U-Profil Kledningsprofil		Venstre	G	7104129	3,5
		Høyre	G	7104131	3,5
HBS H-Profil kledningsprofil			G	7104132	7,0
HBS Låsklamme Kledningsprofil			G	7104133	0,5

		Utfør.	Art. nr	Vekt
HBS Tripod Topadapter inkl. klembeslag		G	7104111	27,5
HBS Splint				
			2113010	0,3
		G	6130296	0,02
		Fzb	6130203	0,02
			2113011	0,2
		G	6130216	0,01
		Fzb	6130203	0,02
			2113012	0,2
		G	6130296	0,02
		Fzb	6130203	0,02





PAS/HBS Innplanking

		Utfør.	Art. nr	Vekt
AL plank B=200 mm		AL	2153079	3,6
		AL	2153105	4,5
Med lås i hver ende		AL	2153125	5,0
L=770-2500 - Lastklasse 6 (6,0 kN/m ²)		AL	2153165	6,2
L=3050 - Lastklasse 5 (4,5 kN/m ²)		AL	2153195	7,1
		AL	2153255	8,7
		AL	2153305	10,3
AL plank B=295 mm		AL	2153078	4,4
		AL	2153104	5,4
Med lås i hver ende		AL	2153124	6,1
L=770-1964 - Lastklasse 6 (6,0 kN/m ²)		AL	2153164	7,5
L=2500 - Lastklasse 5 (4,5 kN/m ²)		AL	2153194	8,6
L=3050 - Lastklasse 4 (3,0 kN/m ²)		AL	2153254	10,5
		AL	2153304	12,4
AL plank B=320 mm		AL	2153077	4,7
		AL	2153103	5,7
L=1250-1964 - Lastklasse 6 (6,0 kN/m ²)		AL	2153123	6,4
L=2500 - Lastklasse 5 (4,5 kN/m ²)		AL	2153163	7,9
L=3050 - Lastklasse 4 (3,0 kN/m ²)		AL	2153193	9,1
		AL	2153253	11,0
		AL	2153303	13,1

Tribune

		Utfør.	Art. nr	Vekt
Stolseksjon 	Stolseksjon tribune 1		2022111	9,7
	Stolseksjon tribune 2		2022112	19,5
	Stolseksjon tribune 3		2022113	29,0
	Stag stolseksjon 1050	G	7104100	4,5
	Låsing stolseksjon	G	7161510	0,9
Tribunekonsoll Bærer Alu-planken på ståplass og i trapp 		G	7211002	3,4
Sparkebord Benyttes som sikring i trapp 	1655	G	2028160	9,2
Rekkverksgrind Håndlist og grind tilpasset trapp 	1050	G	7053100	15,2

Skiltstillas







		Utfør.	Art. nr	Vekt
Motvekt 	Motvekt betong 1500 kg		2121000	1500
	Skive SRB 21x36x3	G	6130296	0,02
	Skrue M20x140	G	6130350	0,4
	Firkanttrør 50x50-650	G	7156000	4,2
Bunnskrue Leddet bunnrør L=1200 mm Ø 60 mm Justerbar 176-711 mm Nøkkelvidde 22 mm 	BSLL 1200	G	7153007	19,4
Bøylegruppe løs 4x60° 	4x60	G	7206000	2,6
Kopling fast Vinklet 30° Nøkkelvidde 22 mm 	KF 34x48 30	G	7164000	1,1

	Utfør.	Art. nr	Vekt
Belysningskonsoll	G	7213000	1,8

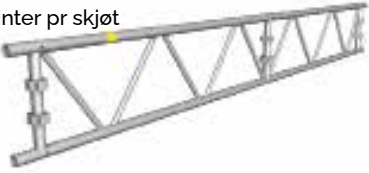

Nøkkelvidde 22 mm



450 Komponenter

		Utfør.	Art. nr	Vekt	
450 Fagverksdrager m/bøyer	2220	AL	4032211	9,9	
	4100	AL	4032411	17,8	
	Med bøyer vertikalt og hull i øverste rør for skinnefeste.	6100	AL	4032611	25,8
	Dragerne skjøtes med 2 stk rette skjøterør 7203000 og 8 stk 12mm splinter pr skjøt	8100	AL	4032811	34,0
					
450 Fagverksdrager	4100	AL	4032410	16,7	
	6100	AL	4032610	24,3	
	Fagverksdrager skjøtes med 2 stk. rette skjøterør 7203000 og 8 stk 12mm splinter	8100	AL	4032810	32,2
					
450 Skjøterør	Skjøterør 22,5 nedre	G	7201316	2,6	
	Skjøterør rett	G	7203000	2,0	
	Skjøterør 30 nedre	G	7203003	2,8	
	Skjøterør 30 øvre	G	7203004	5,7	
	Skjøterør 15 nedre	G	7203005	2,3	
	Skjøterør 15 øvre	G	7203008	4,0	
	Skjøterør 22,5 øvre	G	7203013	4,2	
	Skjøterørene skal monteres med 4 st låsesplinter 12 mm pr skjøterør				
					
450 Skjøterør takfot	Skjøterør takfot 15 inne	G	7201313	2,6	
	Skjøterør takfot 22,5 inne	G	7201315	2,9	
	Skjøterør takfot 15 yttre	G	7203012	5,1	
	Skjøterør takfot 22,5 yttre	G	7203014	3,9	
	Skjøterørene skal monteres med låsesplint 12 mm				
					
450 Endestykke til Fagverksdrager		G	7203338	5,8	
					
450 Diagonalstag teleskopisk		AL	4141020	8,1	
Med bøylefester					
For fagverksdrager 450 AL med bøyer					
For fagstorlekar 3050x1960 mm,					
3050x1920 mm samt					
3050x1880 mm med					
tre faste posisjoner					
					







		Utfør.	Art. nr	Vekt
Enkeltbjelke	LBE 3050	G	8722300	10,5
<p>Andre lengder på forespørsel</p> <p>Med fjærlås</p> <p>Rørdiameter 42 mm</p>				
Takfotsbeslag		G	7014000	3,8
				
Forsterkningsdetalj		G	7142000	10,1
				
Hjul for tak		G	7142001	14,5
				
Låsebeslag for hjul		G	7165002	5,3
				
450 Opphengsbleslag LB		G	7175003	5,6
<p>Nøkkelvidde 22 mm</p> <p>For montering av fagverksdrager 450 AL som rullebane for tak</p> <p>Monteres på doble lengdebjelker</p>				
450 Veggstolpe		G	7014010	12,7
				

		Utfør.	Art. nr	Vekt
450 Skinne	2000	AL	7541200	4,2
	3360	AL	7541336	7,2
<p>L=2000 og 3360 mm</p> <p>Med 7540001 Skjøtepinne AL</p> <p>montert i øvre enden</p> <p>Merket med art. nr i øvre enden</p> 				
450 Skinne takfot		Fzb	7541004	1,0
<p>Monteres med 1 stk låsesplint 12 mm</p> 				
450 Mønerulle	3050	G	7500030	15,5
				





Bunnkomponenter

		Utfør.	Art. nr	Vekt
Bunnskrue		G	2071000	5,0
Justerbar 55-570 mm				



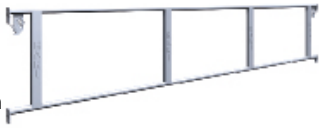

Rammer

			Utfør.	Art. nr	Vekt
Ramme 2000		RA 2000	G	8731204	17,1
Ramme 2000 AL		RA 2000	AL	4731201	8,9
Ramme 1000		RA 1000	G	8731104	12,4
Ramme 1000 AL		RA 1000	AL	4731101	6,4
Ramme 800		RA 800	G	8731084	10,0
Ramme 800 AL		RA 800	AL	4731081	5,1
Ramme 500		RA 500	G	8731053	7,0
Ramme 500 AL		RA 500	AL	4731051	3,8
Ramme med fotlist		RAF 1000	G	8731105	14,5
Ramme med fotlist		RAF 1000	AL	4731105	7,7
L-ramme		RAL 1000	G	8734100	6,1
		RAL 2000	G	8734200	9,8





Rekkverk

			Utfør.	Art. nr	Vekt
Rekkverksramme GFL		700	G	7052070	3,8
		1250	G	7052124	5,7
Med fjærlås		1655	G	7052164	7,4
Rør octagon 28 mm		1964	G	7052194	8,1
		2500	G	7052254	9,2
		3050	G	7052304	10,5
Rekkverksramme AL			SKRD 700	AL	4052066
		SKRD1250	AL	4052121	4,8
Med fjærlås		SKRD 1655	AL	4052161	5,9
		SKRD 1964	AL	4052191	6,6
		SKRD 2500	AL	4052246	7,8
		SKRD 3050	AL	4052301	8,9
Rekkverksramme		SKRDF 700	G	8753000	7,5
Med fjærlås					
Rekkverksramme SKRA		SKRA 500-700	G	8751075	4,4
					

Forankring

			Utfør.	Art. nr	Vekt
Veggfestestag rør		SVF 450x48	G	8832046	2,2
		SVF 600x48	G	8832061	2,6
Krok 16 mm		SVF 900x48	G	8832091	3,7
Tillatt belastning 9,0 kN		SVF 1200x48	G	8832121	4,8
Monteres med kopling fast 48x48					
Kompositteveggfeste		700x48		2021405	1,0
		1000x48		2021403	1,2
Krok 12mm		Endedeksel		2021407	0,1
Tillatt belastning 3,0 kN					
Monteres med kopling fast 48x48					
Kan leveres i forskjellige farger og med logo iht kundens ønsker.					
Veggfestestag		SVF 600	G	7072060	0,6
		SVF 800	G	7072080	0,8
Stang Ø12 mm					
Tillatt belastning 2,5 kN					
Veggfestebøyle		BVF	G	7071000	0,6
For montering av veggfestestag SVF					

Innplanking

		Utfør.	Art. nr	Vekt
Plan B=620 mm		AL	4081070	7,9
Lastklasse 3 (2,0 kN/m ²)		AL	4081120	10,3
		AL	4081160	11,7
		AL	4081190	14,0
		AL	4081250	20,0
		AL	4081300	22,5
Plan B=310 mm		AL	4082160	8,4
Lastklasse 3 (2,0 kN/m ²)		AL	4082190	9,5
		AL	4082245	12,3
		AL	4082300	14,7
Lukeplan		AL	4081191	14,5
Lastklasse 3 (2,0 kN/m ²)		AL	4081245	19,5
		AL	4081302	23,5
Stige		AL	2091210	3,4
	2100			





Fotlister

		Utfør.	Art. nr	Vekt
Fotlist			2025331	5,8
Tre, gul transparent				
Fotlist i ubehandlet tre			2025305	5,0
				
Fotlistbeslag			1162001	0,6
				









Konsoller

			Utfør.	Art. nr	Vekt
Konsoll		SK 300	G	8775030	3,9
		SK 700	G	8775070	7,9
Nøkkelvidde 22 mm		SK 800	G	8775080	9,1
Konsoll AL		SK 700 22 mm	AL	4211072	3,5
Konsoll SK 700 med og konsoll SK 650 uten spiretopp Nøkkelvidde 22 mm					

Trapper

			Utfør.	Art. nr	Vekt
UTV Trapp AL		Låsesplint 12 mm		2113100	0,1
		Gelender HL 2500x2000	AL	4058245	9,2
Med hvilplan og låsing		Gelender HL 3050x2000	AL	4058300	10,3
LxH 3050x2000 mm alt. 2500x2000 mm		Trapp UTV 1000	AL	4102100	9,0
Bredde 600 mm		Trapp UTV 2500x2000	AL	4102247	22,9
		Trapp UTV 3050x2000	AL	4102302	29,2
		STS Gelenderstolpe 1000	G	7015102	4,2
		Feste til STS Gelenderstolpe UTV.AL	G	7058300	1,5
UTV Trapp		Trapp UTV 3050x2000	G	2092200	39,7
		Låsesplint 12 mm		2113100	0,1
Med hvilplan og låsing		Gelender HL 3050x2000	G	2161300	19,3
LxH 3050x2000 mm		STS Gelenderstolpe 1000	G	7015102	4,2
Bredde 600 mm		Feste for STS Gelenderstolpe - UTV	G	8752001	2,5
Overgangsplate til UTV trapp				7211044	3,6
For tetting av åpning mellom trapp og plan					
Stillashenger				6265H00	317,00
Stillashenger for rammestillas. Totalvekt 1300 kg Nyttelast 983 kg					



Øvrige komponenter

			Utfør.	Art. nr	Vekt
Opplagsbjelke		ULB 700	G	8743700	2.4
Låsebjelke		LSB 700	G	8744701	2.3
		LSB 0,7	G	8744700	2.3
Tverrprofil		TP 700	G	8743701	3.7
Nøkkelvidde 22 mm					
Løs Bøylegruppe			G	8792000	0.6
For rekkverk ved hjørneløsninger					
Nøkkelvidde 22 mm					
Låseklammer rekkverk			G	8833000	0.8
For Rekkverk,, rørdiameter 38 mm					
Nøkkelvidde 22 mm					
Låsekrok			G	8793000	0.1
Til låsing av spireskjøt ved belastning, f.eks. ved løft eller inndekking. Ikke for hengende stillaser!					
Markramme			G	8732201	39.5
Med 2 faste og 2 skyvbare spirtopper					
Fag bredde 1460 mm					
Rammetainer			G	8871000	28.9
Til 20 stk. stående rammer					
Rammene surres til rammetainer med spennbånd					





Stillasrør



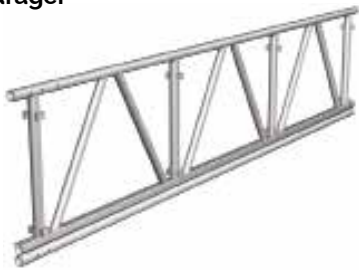

		Utfør.	Art. nr	Vekt
	Stillasrør	G	7241100	4,1
		G	7241150	6,1
		G	7241200	8,0
		G	7241250	10,3
		G	7241300	12,4
		G	7241350	14,1
		G	7241400	16,7
		G	7241450	18,0
		G	7241500	20,1
	G	7241600	24,1	

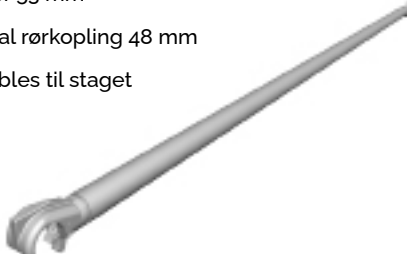





Rørkoplinger







		Utfør.	Art. nr	Vekt
Kopling fast Nøkkelvidde 22 mm			2048010	1,2
		RA 48x48 22	G	
Kopling vridbar Nøkkelvidde 22 mm			2048011	1,4
		SW 48x48 22	G	
Øvrige koplinger			2042000	1,7
	Kopling fast KF 48x60		2042001	1,9
	Kopling vridbar KV 48x60	G	2044000	1,3
	Bjelkekopling SK 48 1-19	G	2045001	1,3
	Rørskjøt 48	G	2045002	0,6
	Støttepinne	G	2044004	1,6
Bøylekobling 		G	2048017	1,4
	Kpl 48			

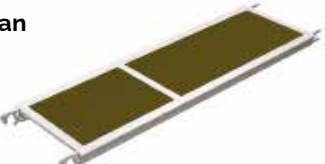



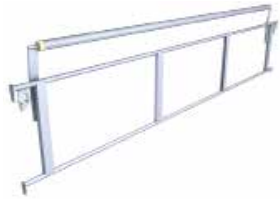

HAKITEC 750 Værbeskyttelse









		Utfør.	Art. nr	Vekt
750 Fagverksdrager 	1250	AL	4032125	9,4
	2250	AL	4032225	16,6
	3250	AL	4032325	23,9
	6250	AL	4032625	46,0
750 Fagverksvinkel 	15°	AL	4202260	18,3
	22,5°	AL	4202261	17,6
	37,5°	AL	4202262	16,6
750 Skjøterør 		G	7203001	2,0
750 Diagonalstag Rørdiameter 53 mm OBS! Normal rørkopling 48 mm kan ikke kobles til staget 	1250x1250	AL	4122121	2,7
	1250x2000	AL	4122123	4,0
	1250x2250	AL	4122124	4,0
	1655x1250	AL	4122162	3,4
	1655x2000	AL	4122163	3,3
	1655x2250	AL	4122164	4,0
	1964x1250	AL	4122192	3,7
	1964x2000	AL	4122193	4,3
	1964x2250	AL	4122194	4,6
	2500x1250	AL	4122249	4,4
	2500x2250	AL	4122253	5,1
	2500x2000	AL	4122254	4,9
	3050x1250	AL	4122299	5,0
	3050x2000	AL	4122303	5,5
	3050x2250	AL	4122304	5,6
750 Rekkverksstolpe 		G	7203322	10,5

			Utfør.	Art. nr	Vekt
750 Kopling vridbar		vert. 48	G	2048007	1,8
		hor. 48	G	2048008	1,8
750 Fagverksopplag			G	7203335	16,8
750 Klembeslag			G	5231617	1,6
750 Fagverksopplag			G	7203325	16,8
750 Bunnramme			G	7203320	10,4
750 Fagverksopplag/bunnramme med to klembeslag			G	7203336	22,5
750 Fagverksopplag/bunnramme uten klembeslag			G	7203326	22,5

		Utfør.	Art. nr	Vekt
750 Fasthjul med spor		G	7142003	9,9
750 Krok løftesikring		G	7175049	3,1
	Skrue M6S M12x40	G	6130323	0,0
	Mutter M12 Nylon	Fzb	6130208	0,0
750 Krok løftesikring for justerbart hjul		G	7175062	10,0
U-profil løftesikring		3000	G 7175050	16,0
	2000	G	7175051	10,6
	Skrue M6S M12x40	G	6130282	0,0
	Mutter M12 Nylon	Fzb	6130267	0,0
750 Triangelbjelke		2000	G 7203332	31,7
	3000	G	7203333	44,0
Triangelkopling		Overdel	G 2044100	1,3
	Underdel	G	2044101	0,7
750 Endestykke til Fagverksdager		G	7203337	6,9
750 Monteringsplan		2000	AL 7500004	14,5
	2250	AL	7500005	16,3

		Utfør.	Art. nr	Vekt
750 Trekkestang		1250	G 7500012	2,5
		1655	G 7500026	3,6
		2500	G 7500007	5,5
		3050	G 7500006	6,8
750 Åk for trekking av duk		1250	G 7500011	7,8
		1655	G 7500025	9,4
		For dukmontering 1964	G 7500017	10,6
		2500	G 7500009	12,6
		3050	G 7500008	14,8
750 Dukstrekker		1250	G 7500013	5,9
		1655	G 7500027	7,6
		1964	G 7500040	7,0
		2500	G 7500014	10,6
		3050	G 7500015	12,9
750 Dukstrekkerrør		1250	G 7500024	4,3
		1655	G 7500028	5,9
		1964	G 7500042	5,6
		2500	G 7500023	9,2
		3050	G 7500022	11,3
750 Ramme med rulle for møne		1250	G 7500018	11,2
		1655	G 7500019	13,9
		1964	G 7500041	16,0
		2500	G 7500020	17,9
		3050	G 7500021	20,5
750 Skinne møne		15°	AL 7541015	2,8
		22.5°	AL 7541022	2,8
		Takvinkel 15°, 22.5° alt. 37.5° 37.5°	AL 7541037	3,0
Uten montert 7540001 Skjøtepinne AL Merket med art. nr i en ende				
750 Skinne		1250	AL 7541125	2,6
		2250	AL 7541225	4,7
		L=1250, 2250, 3250 og 6250 mm 3250	AL 7541325	6,7
		Med 7540001 Skjøtepinne AL 6250	AL 7541625	12,9
montert i øvre enden Merket med art. nr i øvre enden				

			Utfør.	Art. nr	Vekt
750 Skinne takfot Takvinkel 15°, 22,5° alt. 37,5° Med 7540001 Skjøtepinne AL montert i øvre ende Merket med art. nr. i øvre ende		15°	AL	7541150	3,3
		22,5°	AL	7541220	3,3
		37,5°	AL	7541370	3,3
750 Trak Feste for fallsikring			G	7541006	7,6
750 Feste for fallsikring - Komplet For HAKITEC 750 med HAKI Trak Med skinne møne takvinkel 15° alt. 22,5°		15°		7541007	10,4
		22,5°		7541008	10,4
750 Rullekonsoll Til montering av presenning			G	7500010	7,4
750 Vridbar kopling SW Nøkkelvidde 22 mm Til spesialprofilen på fagverksdrager 750 AL		vert. 48	G	2048007	1,8
		hor. 48	G	2048008	1,8
750 Skjøtelås			G	7540000	0,2
750 Skjøtepinne			AL	7540001	0,01

		Utfør.	Art. nr	Vekt
750 Skjøtepakning			7540002	0,1
750 Spennbånd		3 m 450 kg	7540003	0,5
750 Skinnefeste			7541000	0,5
<p>Monteres til fagverk 750 AL med 1 stk 2113100 Låsesplint 12 mm OBS! 2112000 Låsesplint med fjær 12 mm anbefales ikke for denne montasjen</p>		Fzb		
750 Skinnefeste kopleing				
750 Skinnefeste takfot			7541002	1,3
<p>Monteres til fagverk 750 AL med 1 stk 2113100 Låsesplint 12 mm OBS! 2113000 Låsesplint med fjær 12 mm anbefales ikke for denne montasjen</p>		Fzb		
Ringnøkkel		19 22	2051019 2051021	0,3 0,3
Med sperre				
Skinnefeste kopleing			2048030	1,0
Nøkkelvidde 22 mm				
Skinnefeste bøyle			7541003	1,0
Med bøylefeste Nøkkelvidde 22 mm		Fzb		
Styring Trak duk			7541005	1,1
For dukmontering		G		

HAKI Trak duk
HAKI Trak duk

PVC belagt polyestervev

Med kederlist

Produseres fra gang til

gang i lengde og bredde

Flammehemmende iht Euroclass

13501-1: B-s2,d0

Pris på forespørsel

HAKI Trak gavelkappe

Med kederlist på en side

Bredde 935 mm





OBS! Dekker kun fagverk

Flammehemmende iht Euroclass

13501-1: B-s2,d0

HAKITEC INNDEKKNING
HAKI flammehemmende duker og nett

		Utfør.	Art. nr	Vekt
HAKITEC 320 FR takduk	3,3 x 40 m		2034048	41,0
Armert plastduk, 320 g/m ² Euroclass 13501-1: B-s3,d0				
HAKITEC 240 FR	3,2 x 30 m		2034049	23,0
Armert plastduk, 240 g/m ² Euroclass 13501-1: B-s3,d0				
HAKITEC 180 FR	3,2 x 30 m		2034050	18,0
Euroclass 13501-1: B-s3,d0				

		Utfør.	Art. nr	Vekt
Fasadenett 140 FR	3,1 x 50 m		2034051	22,0
140 g/ m ² Euroclass 13501-1: B-s3,d0				
Fasadenett 80 FR	3,1 x 50 m		2034052	13,0
80 g/ m ² Euroclass 13501-1: B-s3,d0				
Innfestning HAKITEC duk				
		Utfør.	Art. nr	Vekt
Dukspenner	Dukspenne		2032100	0,03
	Dukspenne lett		2032300	0,01
Beregn en dukspenne pr. 1,5 m ² dekket fasatareal Dukspenner leveres 100/pakke				
				
Festebjelke	950 22 mm		7207096	5,0
	1900 22 mm		7207191	8,0
Nøkkelvidde 22 mm				
				
Dekkplate HAKITEC	Byggplateskrue BTL 4,8x35		2114000	0,0
	Dekkplate 1900	G	7251200	3,3
	Møneplate 15	G	7252001	0,8
Beregn 6 stk byggplateskruer pr. dekkplate, samt 2 stk pr. møneplate Byggplateskrue leveres 250/pakke				
				
Dukstrekker til møne 750	Dukstrekker 2500	G	7213245	10,3
	Dukstrekker 3050	G	7213300	11,6
For HAKITEC duk i 750 tak				
				

Stillasetak

		Utfør.	Art. nr	Vekt
Stillastak	Takbøyle stillas	G	7014001	18,0
	Forlengelsesrør for takbøyle	G	7014002	3,5

Takbøyle = Fakkbredde 700-770 mm

Takbøyle + 1 stk.forlengelsesrør

= Fakkbredde 1050-1250 mm

Takbøyle + 2 stk. forlengelsesrør

= Fakkbredde 1655 mm

Som dukstøtte mellom takbøylene

brukes rekkverksramme

eller lengdebjelke

Takbøyle stillastak

For montasje direkte på en spiretopp

Som forlengning brukes en spire,

maksimalt spire S 1000

Største bredde på stillastaket 1275 mm



G **7014003** 7,0

Register

450 Diagonalstag teleskopisk	35
450 Endestykke til Fagverksdager	35
450 Fagverksdrager	35
450 Fagverksdrager m/bøyle	35
450 Mønerulle	37
450 Opphengsbeslag LB	36
450 Skinne	37
450 Skinne takfot	37
450 Skjøterør	35
450 Skjøterør takfot	35
450 Veggstolpe	36
750 Bunnramme	45
750 Diagonalstag	44
750 Dukstrekker	47
750 Dukstrekkerør	47
750 Endestykke til Fagverksdager	46
750 Fagverksdrager	44
750 Fagverksopplag	45
750 Fagverksopplag	45
750 Fagverksopplag/bunnramme med to klembeslag	45
750 Fagverksopplag/bunnramme uten klembeslag	45
750 Fagverksvinkel	44
750 Fasthjul med spor	46
750 Feste for fallsikring - Komplet	48
750 Klembeslag	45
750 Kopling vridbar	45
750 Krok løftesikring	46
750 Krok løftesikring for justerbart hjul	46
750 Monteringsplan	46
750 Ramme med rulle for møne	47
750 Rekkverksstolpe	44
750 Rullekonsoll	48
750 Skinne	47
750 Skinnefeste	49
750 Skinnefeste kopling	49
750 Skinnefeste takfot	49
750 Skinne møne	47
750 Skinne takfot	48
750 Skjøtelås	49
750 Skjøtepakning	49
750 Skjøtepinne	48
750 Skjøterør	44
750 Spennbånd	49
750 Trak Feste for fallsikring	48
750 Trekkestang	47

750 Triangelbjelke	46
750 Vridbar kopling SW	48
750 Åk for trekking av duk	47
Adapter	18
Adaptor Tripod	18
AL plank B=170 mm	6
AL plank B=200 mm	32
AL plank B=230 mm	6
AL plank B=295 mm	32
AL plank B=320 mm	32
Alu rampe	7
Belysningskonsoll	34
Beslag skyvbar grind	17
Bjelkerytter	15
Bjelkerytter	23
Bjelkerytter dobbel	15
BRS Bjelkerytter	15
Bunnskrue	3
Bunnskrue	33
Bunnskrue	38
Bunnskrue for S6 spirer	23
Bunnskrue leddet	14
Bunnskrue leddet 750	14
Bunnspiss	14
Bøylegruppe løs	33
Bøylekobling	42
Dekkplate AL	16
Dekkplate B=230 mm	7
Dekkplate HAKITEC	51
Dekkplate stål	16
Diagonalstag	22
Diagonalstag DS	4
Diagonalstag for trall/labanklemmer	4
Dukspenner	51
Dukstrekker til møne 750	51
Enkelbjelke	14
Enkeltbjelke	19
Enkeltbjelke	36
Enrørsbjelke	3
Enrørsbjelke	21
Fagverksdrager	10
Fasadenett 14/ 80 FR	51
Festebjelke	51
Forsterkningsdetalj	36
Fotlist	8
Fotlist	8

Fotlist	8
Fotlist	8
Fotlist	40
Fotlistbeslag	8
Fotlistbeslag	40
Fotlist i ubehandlet tre	40
Fotlist teleskopisk	8
HAKI Galge	19
HAKI Offshore galge	20
HAKI Sikkerhetsblokk	20
Hakitainer	19
HAKITEC 320/ 240/180 FR takduk	50
HAKI Trak duk	50
HAKI Trak gavelkappe	50
HBS Diagonalstag	30
HBS Ennrørsbjelke med skrulås SBF	30
HBS Horisontalstag	30
HBS H-Profil kledningsprofil	31
HBS Kledningspanel	31
HBS Låsklamme Kledningsprofil	31
HBS Nedre Bjelke	31
HBS Pilar	30
HBS Sidestag	30
HBS Splint	32
HBS Tripod Topadapter inkl. klembeslag	32
HBS Tåreplateplank	30
HBS U-Profil Kledningsprofil	30
HBS Øvre Bjelke	31
Hjul	17
Hjul for tak	36
Hjørnekonsoll	9
Hjørnekonsoll	10
Horisontaldiagonal HDS	5
Horisontaldiagonal HDS	22
Horisontaldiagonal teleskopisk HDS	22
Hvilplan VLP	27
Høydeinnstillingsspire	14
Innstegstrapp	11
Justerbar Bunnskrue 60	18
Kombikonsoll KK	10
Kombinasjonsbeslag	17
Kombinasjonsbeslag	19
Komposittlem	6
Komposittveggfeste	5
Komposittveggfeste	39
Konsoll	22

Konsoll	22
Konsoll	41
Konsoll AL	41
Konsolldiagonal	9
Konsolldiagonal	23
Konsolldiagonal S6 AL	25
Konsoll justerbar	9
Konsoll med spireskjøt	9
Konsoll med spireskjøt S6 AL	25
Konsoll uten spireskjøt	9
Kopling fast	33
Kopling fast	43
Kopling vridbar	43
Krokplan	7
Lengdebjelke	3
Lengdebjelke	21
L-ramme	38
Lukeplan	40
Lukeplan AL B=690 mm	6
Låsebeslag for hjul	36
Låsebjelke	42
Låsefjær	20
Låsefjær til bunnskrue	14
Låsejern for fotlist	8
Låseklammer rekkverk	15
Låseklammer rekkverk	42
Låsekrok	42
Låselist	23
Låsesplate	23
Låsesplint	18
Låsesplint for offshore med kjetting	18
Låsesplint m/fjær	18
Løs Bøylegruppe	15
Løs Bøylegruppe	42
Markramme	42
Monteringsverktøy for rekkverk	19
Monteringsverktøy låsefjær	20
Motvekt	33
Opplagsbjelke	42
Overgangsplate til UTV trapp	41
PAS Diagonal	29
PAS Enrørsbjelke m dekkplate	29
PAS Gelender	28
PAS Gelender	29
PAS Gelender innsteg	29
PAS Rekkverk	29

PAS Trappevange	29
PAS Trappevange	29
Plan B=310 mm	40
Plan B=620 mm	40
Plankerytter	17
Plankerytter	17
Ramme 500	38
Ramme 500 AL	38
Ramme 800	38
Ramme 800 AL	38
Ramme 1000	38
Ramme 1000 AL	38
Ramme 2000	38
Ramme 2000 AL	38
Ramme med fotlist	38
Ramme med fotlist	38
Rammetainer	42
Rekkverksgrind	33
Rekkverksgrind med nett SGF	4
Rekkverk SKR	4
Rekkverksramme	22
Rekkverksramme	39
Rekkverksramme AL	39
Rekkverksramme GFL	4
Rekkverksramme GFL	39
Rekkverksramme SKRA	39
Rekkverksstolpe	16
Rekkverksstolpe	26
Rekkverksstolpe SRS	16
Rekkverksstolpe SS	16
Ringnøkkel	49
SGT Rekkverksramme Trappetårn	27
Sikkerhetsbøyle	16
Skinnefeste bøyle	49
Skinnefeste kopling	49
Sparkebord	33
Spireholder	15
Spireholder	15
Spireholder S4 AL	23
Spireholder S6 AL	25
Spire S	3
Spire S4 AL	21
Spire S6 AL med splint	24
Splint til spireskjøt	3
Splint til spireskjøt	21
SS Klembeslag	13

SS Monteringsverktøy til hengende	13
SS Opphengsbeslag Bulb-Kjetting	12
SS Opphengsbeslag Bulb-Kjetting	12
SS Opphengsbeslag Bulb-Rør	13
SS Opphengsbeslag Gallerdørk	12
SS Opphengsbeslag H-bjelke	12
SS Opphengsbeslag KF 48 dobbel	13
SS Opphengsbeslag kjetting	13
SS Opphengsbeslag L-bjelke	12
STC Fotlist	28
STC Gelender komplett	28
STC Gelender øvre	28
STC Innstegsbjelke	28
STC Innstegstrapp	28
Stige	40
Stige ST	6
Stillasbukk	19
Stillashenger	41
Stillashjul S6	25
Stillaskjetting med to sjakler	13
Stillaslem Alu	6
Stillasnett 125 FR	51
Stillasrør	43
Stillasskilt	20
Stillastak	17
Stillastak	18
Stillastak	52
Stillastau	20
Stolseksjon	33
STS Fotlist	26
STS Gelender	26
STS Gelenderstolpe	26
STS Gelenderstolpe	27
STS Hvilplan	26
STS Innstegstrapp	27
STS Låsekrok	27
STS Rekkverksgrind	26
STS Rekkverksramme	27
STS Rekkverksramme Trappetårn	27
STS Trappeløp	26
STV Stige med hvilplan	12
Styring Trak duk	49
Takbøyle stillastak	52
Takfotsbeslag	36
Testnøkkel til forankring 350Nm	20
Toppgafler	18

Topplate Tripod	18
Toppspire S4 AL	21
Toppspire S6 AL	24
Toppspire SC	14
Trappeløp TRP	27
Trekantplatninger	7
Triangelkopling	46
Tribunekonsoll	33
Tripod	18
Tverrbjelkebeslag	17
Tverrprofil	42
U-profil løftesikring	46
Utfyllingsplater AL	16
UTV Gelender indre	11
UTV Gelender HL	11
UTV Trapp	11
UTV Trapp	41
UTV Trapp AL	11
UTV Trapp AL	11
UTV Trapp AL	41
Veggfestebøyle	39
Veggfeste justerbart	5
Veggfestestag	39
Veggfestestag rør	39
Veggfestestag rør SVF	5
Veggstag VST	5
Øvrige koplinger	43
Øyeskrue	20

